

# NO-VO<sup>®</sup>

NO-VO Elektronik & Lighting Factory



## 2023 CATALOG

[www.no-vo.com.tr](http://www.no-vo.com.tr)

*We Trust The Future*



We as NO-VO Electronic strive to follow the latest developments by combining 35 years of experience and knowledge with a young, innovative, motivated and committed teammates. Our goal is to offer the most suitable solutions for reasonable prices to our customers without sacrificing quality.

Despite its new establishment, NO-VO Electronic has become one of the preferred brands of the sector in a short time and with its breakthroughs, NO-VO aims to be one of the leading companies in the sector.

Our goal is to be a respected global company in the world to the same extent as in Türkiye. To achieve that we are following the technological developments, keeping customer satisfaction in the forefront and delivering high quality products in a wide range with new ideas and designs.

# LIGHTING FIXTURES WITH MOTION SENSOR



NO-VO<sup>®</sup>

# LIGHTING FIXTURES WITH MOTION SENSOR

## 2 x E27 FIXTURE WITH MOTION SENSOR

(Metal Body & Glass Cover)

 2x9W LED BULB



NV001

## 2 x E27 FIXTURE WITH MOTION SENSOR & EMERGENCY LIGHT

(Metal Body & Glass Cover)

 EMERGENCY LIGHT 5 HOURS ✓  
2x9W LED BULB



NV002

## 2 x E27 FIXTURE WITH MOTION SENSOR

(Metal Body & Transparent PC Cover)

 2x9W LED BULB



NV001.01

## 2 x E27 FIXTURE WITH MOTION SENSOR & EMERGENCY LIGHT

(Metal Body & Transparent PC Cover)

 EMERGENCY LIGHT 5 HOURS ✓  
2x9W LED BULB



NV002.01

## 2 x E27 FIXTURE WITH MOTION SENSOR

(PC Body & Transparent PC Cover)

 2x9W LED BULB



NV001.70

## 2 x E27 FIXTURE WITH MOTION SENSOR & EMERGENCY LIGHT

(PC Body & Transparent PC Cover)

 EMERGENCY LIGHT 5 HOURS ✓  
2x9W LED BULB



NV002.70



230-240V-50/60Hz VOLTAGE



2x9W - E27 RATED LOAD



Max 9m ←→ DETECTION RANGE



2-2.8 m DETECTION HIGH



10 sec ~ 5 dk TIME DELAY



2-2000 lux AMBLANT LIGHT



-20°C ~ +40°C WORKING TEMPERATURE



IP20 PROTECTION



10 PCS 540 x 610 x 310 BOX SIZE

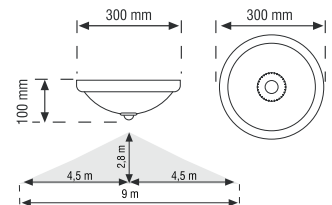

# LIGHTING FIXTURES WITH MOTION SENSOR

## 2 x E27 FIXTURE WITH MOTION SENSOR

(PC Body & Glass Cover)



2x9W  
LED BULB



10 PCS  
540 x 610 x 310  
BOX SIZE



NV001.71

## 2 x E27 FIXTURE WITH MOTION SENSOR & EMERGENCY LIGHT

(PC Body & Glass Cover)

EMERGENCY LIGHT  
5 HOURS ✓



2x9W  
LED BULB



10 PCS  
540 x 610 x 310  
BOX SIZE



NV002.71

## LED LIGHTING FIXTURE WITH MOTION SENSOR

(Metal Body & White PC Cover)



18W



10 PCS  
540 x 610 x 310  
BOX SIZE



3000K  
4000K  
6500K



NV003.10

## LED FIXTURE WITH SENSOR & EMERGENCY LIGHT

(Metal Body & White PC Cover)

EMERGENCY LIGHT  
5 HOURS ✓



18W



10 PCS  
540 x 610 x 310  
BOX SIZE



3000K  
4000K  
6500K



NV004.10

## SLIM LED LIGHTING FIXTURE WITH MOTION SENSOR

(PC Body & PC Cover)



18W



12 PCS  
540 x 610 x 310  
BOX SIZE



3000K  
4000K  
6500K



NV003.33

## LED FIXTURE WITH SENSOR & EMERGENCY LIGHT

(PC Body & PC Cover)

ACIL AYDINLATMA  
5 SAAT ✓



18W



12 PCS  
540 x 610 x 310  
BOX SIZE



3000K  
4000K  
6500K



NV004.33



230-240V~50/60Hz  
VOLTAGE



1440  
Lümen  
LIGHTING POWER



Max 9m  
DETECTION RANGE



2-2.8 m  
DETECTION HIGH



10 sn ~ 15 dk  
TIME DELAY



2-2000 lux  
AMBLENT LIGHT



-20°C ~ +40°C  
WORKING TEMPERATURE



IP 20  
PROTECTION

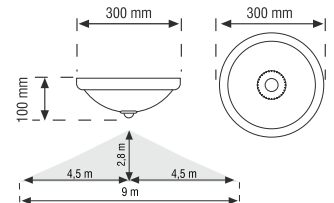

## LED SLIM PANEL WITH MICROWAVE SENSOR

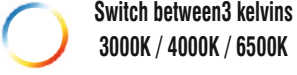

Flush Mountt & Ceiling Mount

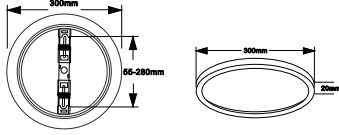

SPL024.33

## LED SLIM PANEL WITH MICROWAVE SENSOR



Flush Mountt & Ceiling Mount

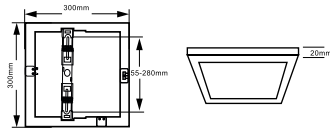

KSPL024.33

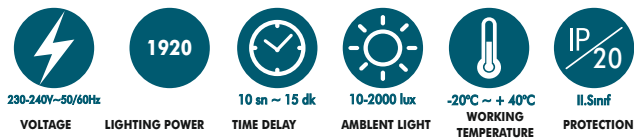

LED SLIM FIXTURE WITH MICROWAVE SENSOR

(White Frame & Sanded Glass)



18W



Switch between 3 kelvins  
3000K / 4000K / 6500K



NV003.31

LED SLIM FIXTURE WITH MICROWAVE SENSOR

(Chrome frame & sanded glass)



18W



Switch between 3 kelvins  
3000K / 4000K / 6500K



NV003.41

LED SLIM FIXTURE WITH MICROWAVE SENSOR

(Matt Chrome Frame & Sanded Glass)



18W



Switch between 3 kelvins  
3000K / 4000K / 6500K



NV003.51



230-240V~50/60Hz  
VOLTAGE



1440  
LIGHTING POWER



10 sn ~ 15 min  
TIME DELAY



2-2000 lux  
AMBLANT LIGHT



-20°C ~ +40°C  
WORKING TEMPERATURE



I.Sınıf  
PROTECTION



10 PCS  
540 x 610 x 310  
BOX SIZE

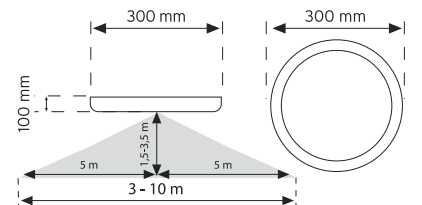

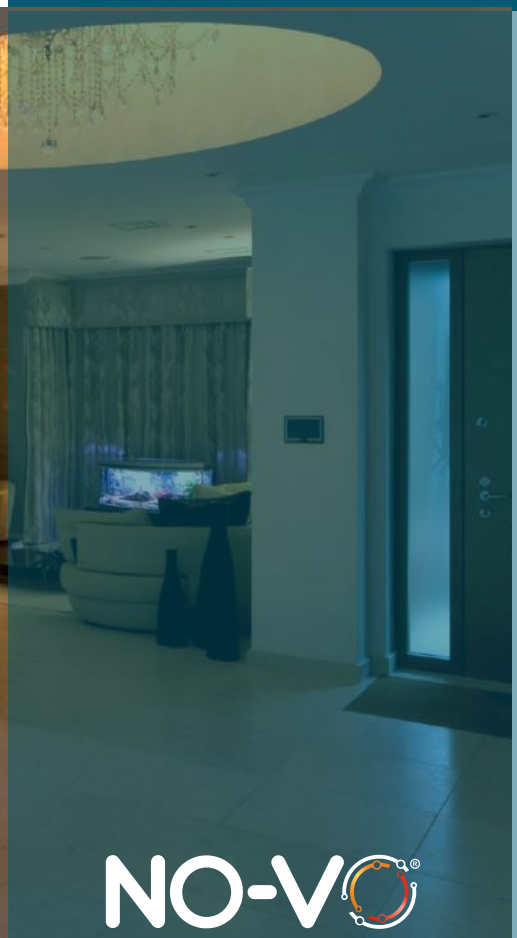

NO-V<sup>o</sup>

## MOTION SENSORS



## PIR MOTION SENSOR

  
**800 W- INC.**  
**400 W - LED**

**100 PCS**  
630x225x265

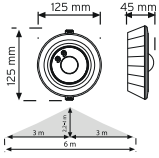

**NV011**

## PIR MOTION SENSOR

  
**1200 W- INC.**  
**400 W - LED**

**100 PCS**  
400x450x370

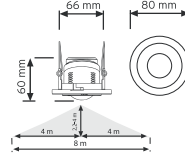

**NV012**

## MICROWAVE MOTION SENSOR

  
**2000 W- INC.**  
**400 W - LED**

**100 PCS**  
550x420x248

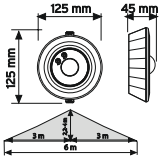

**NV013**

## MICROWAVE MOTION SENSOR

  
**1200 W- INC.**  
**300 W - LED**

**100 PCS**  
550x420x248

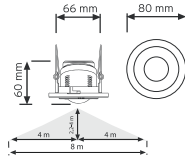



**NV014**

## 3x MOTION SENSOR



  
**2000 W- INC.**  
**1000 W - LED**

**10 sec ~ 10 min**  
**50 PCS**  
600x520x250

  
**DETECTION RANGE**  
**2 - 20M**

**DETECTION HIGH**  
**2.2 - 4M**

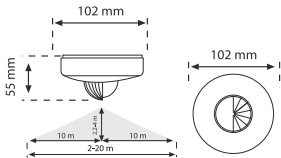

**NV015**

## 3x MOTION SENSOR



  
**2000 W- INC.**  
**1000 W - LED**

**10 sec ~ 7 min**  
**50 PCS**  
600x520x250

  
**DETECTION RANGE**  
**2 - 20M**

**DETECTION HIGH**  
**2.2 - 4M**

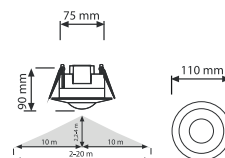

**NV016**



**230-240V~50/60Hz**  
VOLTAGE



**10 sn ~ 15 dk**  
TIME DELAY



**10-2000 lux**  
AMBLANT LIGHT



**-20°C ~ + 40°C**  
WORKING TEMPERATURE



**II.Sınıf**  
PROTECTION



## PIR MOTION SENSOR

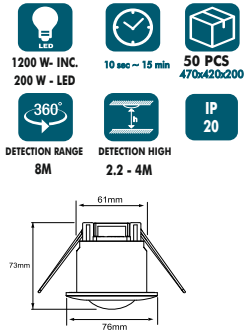

NV012.30

## PIR MOTION SENSOR

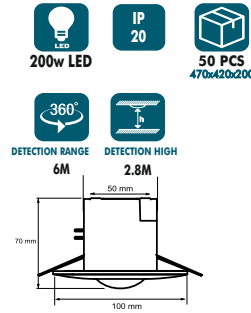

NV012.01

## MINI MOTION SENSOR

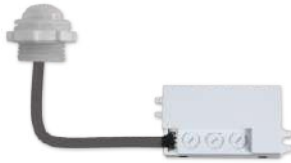
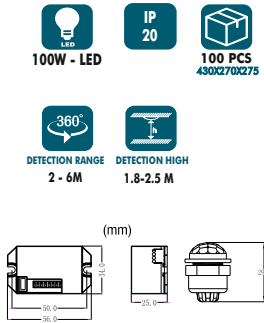

NV017

## MICROWAVE MOTION SENSOR

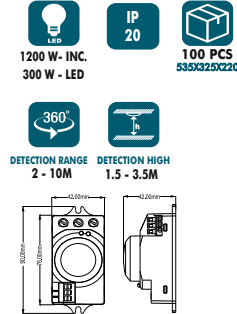

NV018

## PIR MOTION SENSOR

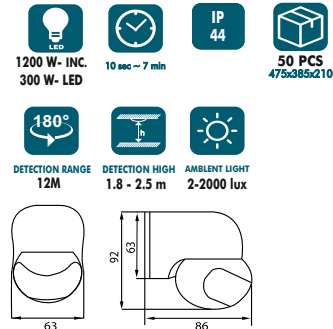

NV020

## PIR MOTION SENSOR

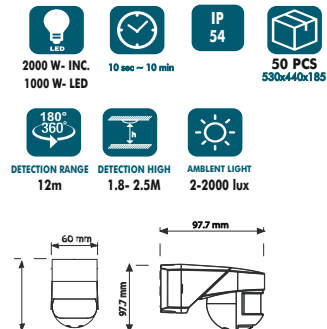

NV021

## WALL MOUNT INFRARED SENSOR

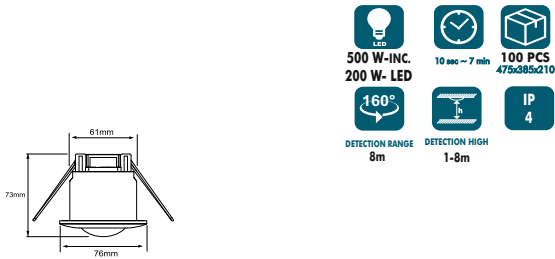

NV022



230-240V~50/60Hz  
VOLTAGE



-20°C ~ + 40°C  
WORKING  
TEMPERATURE





## LED DOWNLIGHT

# LED DOWNLIGHT

## 3W LED SLIM DOWNLIGHT



3000K/4000K/6500K

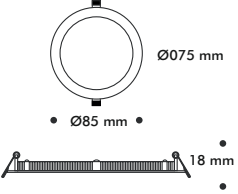

PL003

## 6W LED SLIM DOWNLIGHT

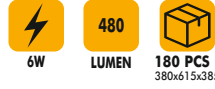

3000K/4000K/6500K

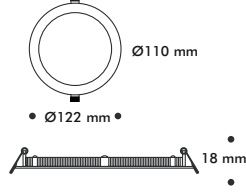

PL006

## 9W LED SLIM DOWNLIGHT



3000K/4000K/6500K

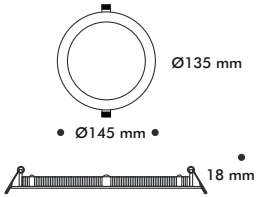

PL009

## 12W LED SLIM DOWNLIGHT



3000K/4000K/6500K

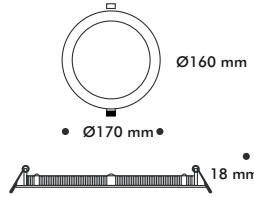

PL012

## 15W LED SLIM DOWNLIGHT



3000K/4000K/6500K

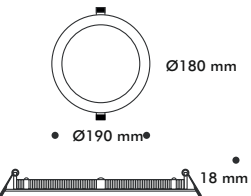

PL015

## 18W LED SLIM DOWNLIGHT



3000K/4000K/6500K

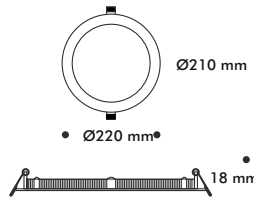

PL018



# LED DOWNLIGHT

## 5W LED DOWNLIGHT

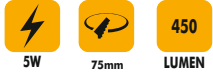

3000K/4000K/6500K

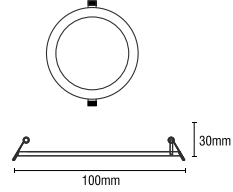

PL005.11

## 7W LED DOWNLIGHT



3000K/4000K/6500K

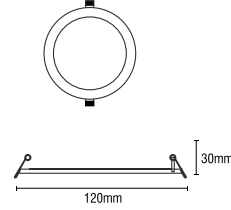

PL007.11

## 12W LED DOWNLIGHT



3000K/4000K/6500K

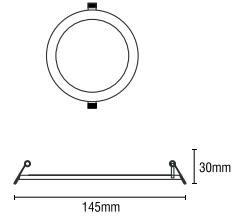

PL012.11

## 16W LED DOWNLIGHT



3000K/4000K/6500K

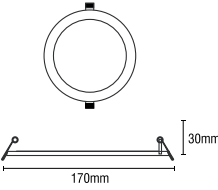

PL016.11

## 22W LED DOWNLIGHT



3000K/4000K/6500K

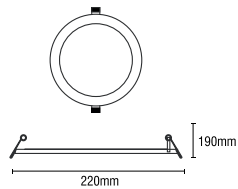

PL022.11





**SURFACE MOUNT & RECESSED MOUNT  
LED ARMATURE**

## 18W CIRCULAR LED PANEL

SPL018



3000K/4000K/6500K

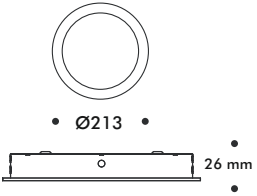

## 24W CIRCULAR LED PANEL

SPL024



3000K/4000K/6500K

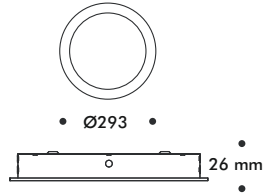

## 18W SQUARE LED PANEL

KSPL018



3000K/4000K/6500K

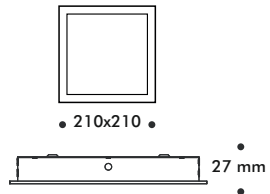

## 24W SQUARE LED PANEL

KSPL024



3000K/4000K/6500K

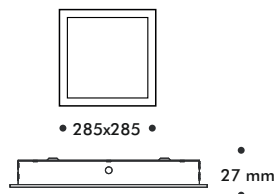

# RECESSED MOUNT LED ARMATURE

## 60x60 36W BACKLIGHT LED PANEL



BP040

## 60x60 36W BACKLIGHT LED PANEL

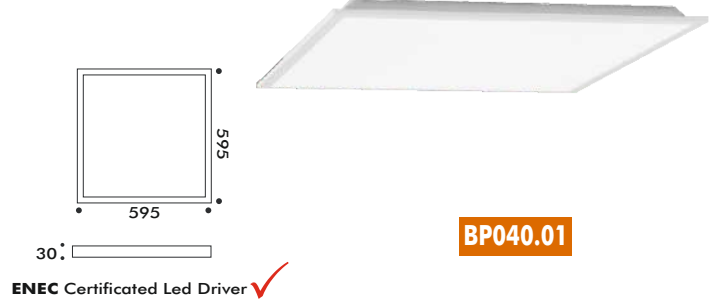

BP040.01

## 60x60 48W BACKLIGHT LED PANEL

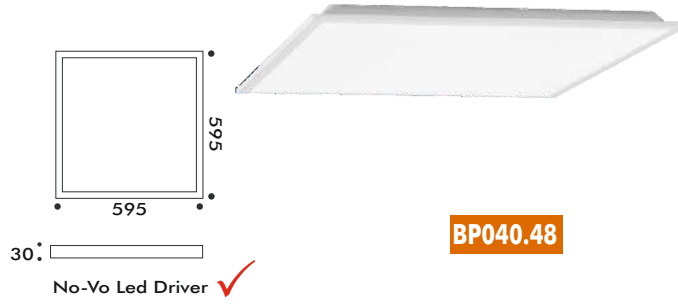

BP040.48

## 60X60 LED PANEL SURFACE MOUNT ACCESSORY



SP041







# LED BATTEN LIGHTING

## 120 CM LED BATTEN LINEAR ARMATURE



BA042.01

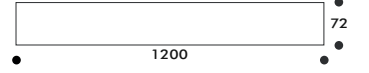

No-Vo Led Driver ✓

## 60 CM LED BATTEN LINEAR ARMATURE



BA042.18

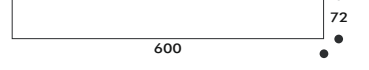

## 54W LED BATTEN LIGHT



BA036.54

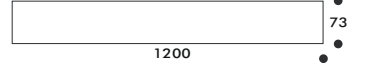

## 72W LED BATTEN LIGHT



BA036.72

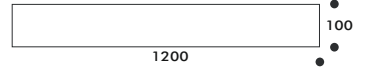

## 96W LED BATTEN LIGHT



BA036.96

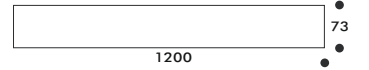

## 120 CM ULTRA SLIM WATERPROOF LIGHTING FIXTURE



BA036.10

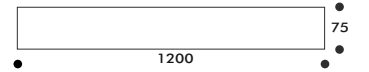

No-Vo Led Driver ✓

## 60 CM ULTRA SLIM WATERPROOF LIGHTING FIXTURE



BA036.11

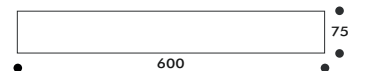

## IP65 WATERPROOF LIGHTING FIXTURE



BA036

36W  
 2880 LUMEN  
 65 IP  
 20 PCS  
 400x1180x320

No-Vo Led Driver ✓

3000K/4000K/6500K

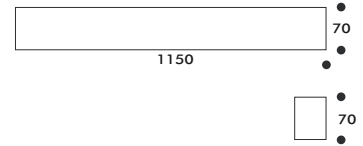

## IP65 WATERPROOF LIGHTING FIXTURE



BA036.05

36W  
 2880 LUMEN  
 65 IP  
 30 PCS  
 360x1245x285

No-Vo Led Driver ✓

3000K/4000K/6500K

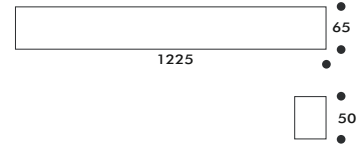

## IP65 SLIM LED WATERPROOF LIGHTING FIXTURE



BA036.03

36W  
 2880 LUMEN  
 65 IP  
 50 PCS  
 360x1245x285

No-Vo Led Driver ✓

3000K/4000K/6500K

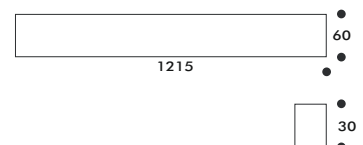

## IP65 LED WATERPROOF LIGHTING FIXTURE



ETJ040

36W  
 2880 LUMEN  
 65 IP  
 GREY CASE COLOR

No-Vo Led Driver ✓

3000K/4000K/6500K

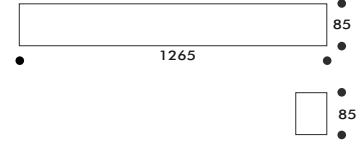

## IP65 LED WATERPROOF LIGHTING FIXTURE - ENEC



ETJ040.01

36W  
 2880 LUMEN  
 65 IP  
 GREY CASE COLOR

ENEC Led Driver ✓

3000K/4000K/6500K

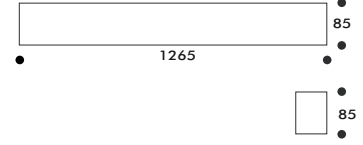

## IP65 LINEAR LED WATERPROOF LIGHTING FIXTURE



BA036.08

36W  
 2880 LUMEN  
 65 IP  
 GREY CASE COLOR

No-Vo Led Driver ✓

3000K/4000K/6500K

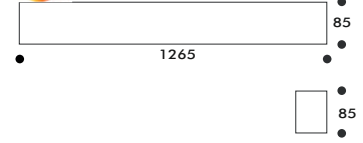

## IP65 LINEAR LED WATERPROOF LIGHTING FIXTURE



BA036.09

36W  
 2880 LUMEN  
 65 IP  
 GREY CASE COLOR

ENEC Led Driver ✓

3000K/4000K/6500K

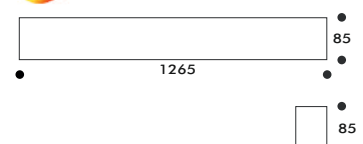

220-265V  
 POWER UNIT  
 LED  
 PC BODY  
 SURFACE MOUNT

Made in Türkiye



**LED BULB**

## 9W LED BULB

**9W** **810** **300 PCS**  
LUMEN 660 x 396 x 632

**E27** **A60** **LED**  
SOCKET TYPE BODY SIZE

3000K/4000K/6500K

A009



## 12W LED BULB

**12W** **1080** **200 PCS**  
LUMEN 670x40x508

**E27** **A65** **LED**  
SOCKET TYPE BODY SIZE

3000K/4000K/6500K

A012



## 15W LED BULB

**15W** **200 PCS** **1350**  
LUMEN 650x525x475

**E27** **A65** **LED**  
SOCKET TYPE BODY SIZE

3000K/4000K/6500K

A015



## 7W LED BULB

**7W** **630** **LED**  
LUMEN

**E14** **C37**  
SOCKET TYPE BODY SIZE

3000K/4000K/6500K

A007.01



## 7W LED BULB

**7W** **23** **630**  
IP LUMEN

**E14** **C37** **LED**  
SOCKET TYPE BODY SIZE

3000K/4000K/6500K

A007.02



## 7W GU10 LED BULB

**7W** **23** **630**  
IP LUMEN





**GU10** **LED**  
SOCKET TYPE

3000K/4000K/6500K

A007.03



## 20W LED TORCH BULB



 **20W**  
 **1465**  
**LUMEN**  
 **50 PCS**  
435x435x305  
 **E27**  
 **T80**  
**LED**  
SOCKET TYPE BODY SIZE  
 **3000K/4000K/6500K**



T20



## 30W LED TORCH BULB



 **30W**  
 **2098**  
**LUMEN**  
 **50 PCS**  
435x630x350  
 **E27**  
 **T100**  
**LED**  
SOCKET TYPE BODY SIZE  
 **3000K/4000K/6500K**



T30



## 40W LED TORCH BULB







 **40W**  
 **3668**  
**LUMEN**  
 **40 PCS**  
650x525x475  
 **E27**  
 **T125**  
**LED**  
SOCKET TYPE BODY SIZE  
 **3000K/4000K/6500K**



T40



## 50W LED TORCH BULB

 **50W**  
 **4523**  
**LUMEN**  
 **32 PCS**  
575x570x480  
 **E27**  
 **T140**  
**LED**  
SOCKET TYPE BODY SIZE  
 **3000K/4000K/6500K**



T50



## 100W LED TORCH BULB







 **100W**  
 **23**  
**IP**  
 **9000**  
**LUMEN**  
 **E27**  
 **T150**  
**LED**  
SOCKET TYPE BODY SIZE  
 **3000K/4000K/6500K**



T100



## 150W LED TORCH BULB

 **150W**  
 **23**  
**IP**  
 **13500**  
**LUMEN**  
 **E27**  
 **T170**  
**LED**  
SOCKET TYPE BODY SIZE  
 **3000K/4000K/6500K**



T150



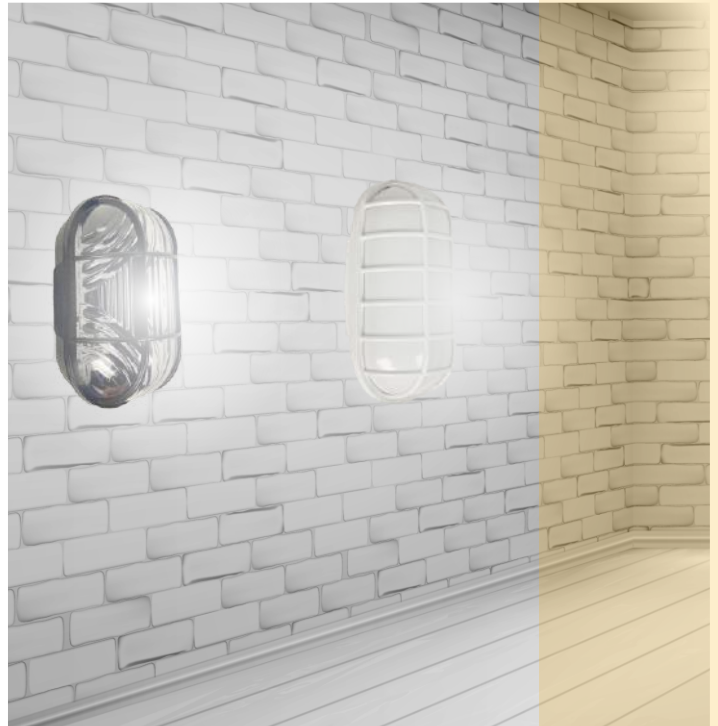

## LED LIGHTING FIXTURES

## 50W LED FLOOD LIGHT

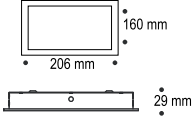

PRJ050

## 100W LED FLOOD LIGHT

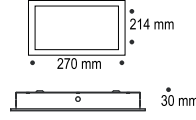

PRJ100

## 150W LED FLOOD LIGHT

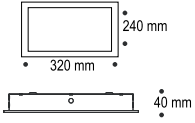

PRJ150

## 200W LED FLOOD LIGHT

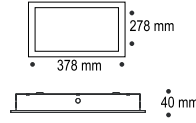

PRJ200

## 300W LED FLOOD LIGHT

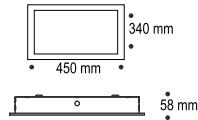

PRJ300





## 75W LED HIGH BAY LIGHT FIXTURE

**75W** **6000** **ALUMINUM** **3000K/4000K/6500K**  
LUMEN CASE

Osram led ✓  
2x Osram Driver ✓



**YT080.01** **OSRAM**

## 80W LED HIGH BAY LIGHT FIXTURE

**80W** **9200** **ALUMINUM** **3000K/4000K/6500K**  
LUMEN CASE

Osram led ✓  
ithal Driver ✓

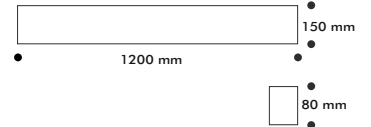

**YT080**

## 120W LED HIGH BAY LIGHT FIXTURE

**120W** **13800** **ALUMINUM** **3000K/4000K/6500K**  
LUMEN CASE

Osram led ✓  
2x Osram Driver ✓



**YT120** **OSRAM**

## 160W LED HIGH BAY LIGHT FIXTURE

**160W** **18400** **ALUMINUM** **3000K/4000K/6500K**  
LUMEN CASE

Osram led ✓  
ithal Driver ✓

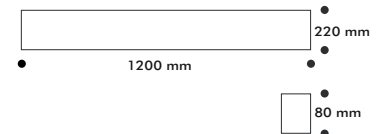

**YT160** **OSRAM**



## 16W LED PLASTIC CEILING FIXTURE

 **1280** **16W** **LUMEN** **CASE COLOR** **WHITE** **BLACK**  **3000K/4000K/6500K**



**SPL018.16**

## 30W LED TRACK LIGHT

 **2400** **30W** **LUMEN** **CASE COLOR** **WHITE** **BLACK**  **3000K/4000K/6500K**

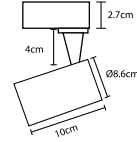

**NRS030**

## WALL MOUNT LED FIXTURE

 **1280** **16W** **LUMEN** **CASE COLOR** **WHITE** **BLACK**  **3000K/4000K/6500K**

\* Dust and water resistant

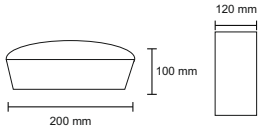

**SPL018.20**

## WALL MOUNT LED FIXTURE

 **1280** **16W** **LUMEN** **CASE COLOR** **WHITE** **BLACK**  **3000K/4000K/6500K**

\* Dust and water resistant

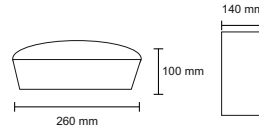

**SPL018.21**

## EMERGENCY LIGHTING KIT 3 HOUR

 **50/60Hz** **200V** **FREKANS** **ABS PLASTIC** **CASE TYPE** **3.6V 800 mAh** **BATTERY**



**NACL02**

Compatible with all brands of LED drivers ✓  
Battery overcharge and discharge protection ✓

## EMERGENCY LIGHTING KIT 1 HOUR

 **50/60Hz** **200V** **FREKANS** **ABS PLASTIK** **KASA TIPI** **3.6V 1500 mAh** **BATARYA**



**NACL01**

Compatible with all brands of LED drivers ✓  
Battery overcharge and discharge protection ✓



## ***WALLWASHER LIGHTING***

# SURFACE MOUNT WALLWASHER



LUMEN

3W - 12cm

240



LUMEN

6W - 20cm

480



LUMEN

9W - 28cm

720



LUMEN

12W - 35cm

960



LUMEN

18W - 50 cm

1440



LUMEN

24W - 67cm

1920



LUMEN

36W- 98cm

2880



LUMEN

42W - 113cm

3360



LUMEN

54W - 145 cm

4320

IP67

AC85-265v  
50/60 Hz

ALUMINUM

IK10

CRI  
80+

4MM  
TEMPERED  
OPTICAL GALSS

OPERATING  
TEMPERATURE  
-40C / +80C

2 YEARS  
GUARANTY

NVWXXSU-3K	NVWXXSU-4K	NVWXXSU-6K	NVWXXSU-A	NVWXXSU-R	NVWXXSU-G	NVWXXSU-B	NVWXXSU-P	NVWXXSU-T	NVWXXSU-RGB
3000K	4000K	6500K	AMBER	RED	GREEN	BLUE	PiNK	TURQUOISE	RGB

# RECESSED MOUNT WALLWASHER



3W - 17cm

LUMEN

240



6W - 24cm

LUMEN

480



9W - 32cm

LUMEN

720



12W - 44cm

LUMEN

960



18W - 55 cm

LUMEN

1440



24W - 71cm

LUMEN

1920



36W- 102cm

LUMEN

2880

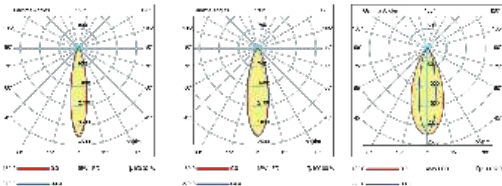

IP67

AC85-265v  
50/60 Hz

ALUMINUM

IK10

CRI  
80+

4MM  
TEMPERED  
OPTICAL GALSS

OPERATING  
TEMPERATURE  
-40C / +80C

2 YEARS  
GUARANTY

NVWXXRE3K	NVWXXRE4K	NVWXXRE6K	NVWXXREA	NVWXXREK	NVWXXREY	NVWXXREM	NVWXXREP	NVWXXRET	NVWXXRERGB
3000K	4000K	6500K	AMBER	RED	GREEN	BLUE	PINK	TURQUOISE	RGB

# LED LINEAR LIGHTING

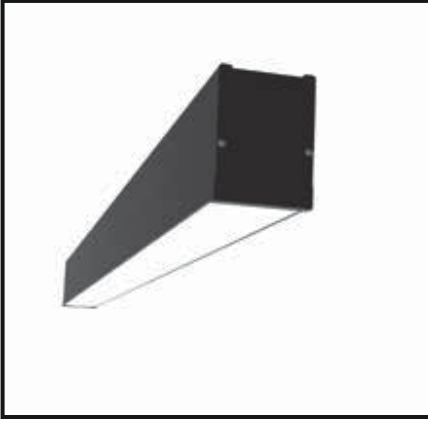

## CODE

NVL5075 90 60  
 NVL5075 90 80  
 NVL5075 90 100  
 NVL5075 90 120  
 NVL5075 90 150  
 NVL5075 90 180  
 NVL5075 90 200  
 NVL5075 90 250  
 NVL5075 90 300



## CODE

NVL6080 T 90 60  
 NVL6080 T 90 80  
 NVL6080 T 90 100  
 NVL6080 T 90 120  
 NVL6080 T 90 150  
 NVL6080 T 90 180  
 NVL6080 T 90 200  
 NVL6080 T 90 250  
 NVL6080 T 90 300



## CODE

NVL6080 C 90 60  
 NVL6080 C 90 80  
 NVL6080 C 90 100  
 NVL6080 C 90 120  
 NVL6080 C 90 150  
 NVL6080 C 90 180  
 NVL6080 C 90 200  
 NVL6080 C 90 250  
 NVL6080 C 90 300

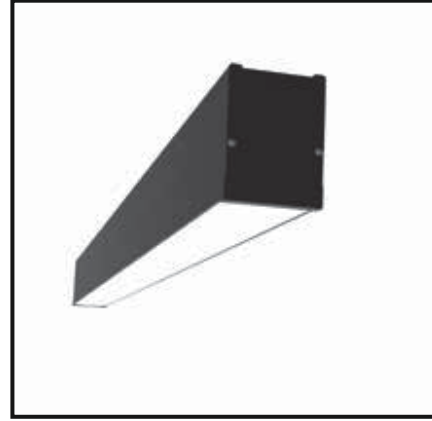

## CODE

NVL3441 90 60  
 NVL3441 T90 80  
 NVL3441 T 90 100  
 NVL3441 T 90 120  
 NVL3441 T90 150  
 NVL3441 T 90 180  
 NVL3441 T 90 200  
 NVL3441 T 90 250  
 NVL3441 T 90 300



## CODE

NVL8590 90 60  
 NVL8590 90 80  
 NVL8590 90 100  
 NVL8590 90 120  
 NVL8590 90 150  
 NVL8590 90 180  
 NVL8590 90 200  
 NVL8590 90 250  
 NVL8590T 90 300



## CODE

NVS7545 90 60  
 NVS7545 90 80  
 NVS7545 90 100  
 NVS7545 90 120  
 NVS7545 90 150  
 NVS7545 90 180  
 NVS7545 90 200  
 NVS7545 90 250  
 NVS7545 90 300

W	LUMEN	LENGHT	W	LUMEN	LENGHT
18W	1440	600	65W	5200	1800
25W	2000	800	70W	5600	2000
35W	2800	1000	90W	7200	1500
44W	3520	1200	105W	8400	3000
55W	4400	1500			

- IP 20
- AC100-277V
- SAMSUNG LED PHILIPS DRIVER
- IK10
- CRI 80+
- ALUMINUM
- OPERATING TEMPERATURE -20C / +45C
- 2 YEARS GUARANTY

## **BATTERY OPERATED SMOKE DEDECTOR ( BATTERY INCLUDED)**

- DC 9V battery
- Stand Alone Feature
- Working Temperature : -10/ + 55C°
- Size Ø100mm, h:31mm



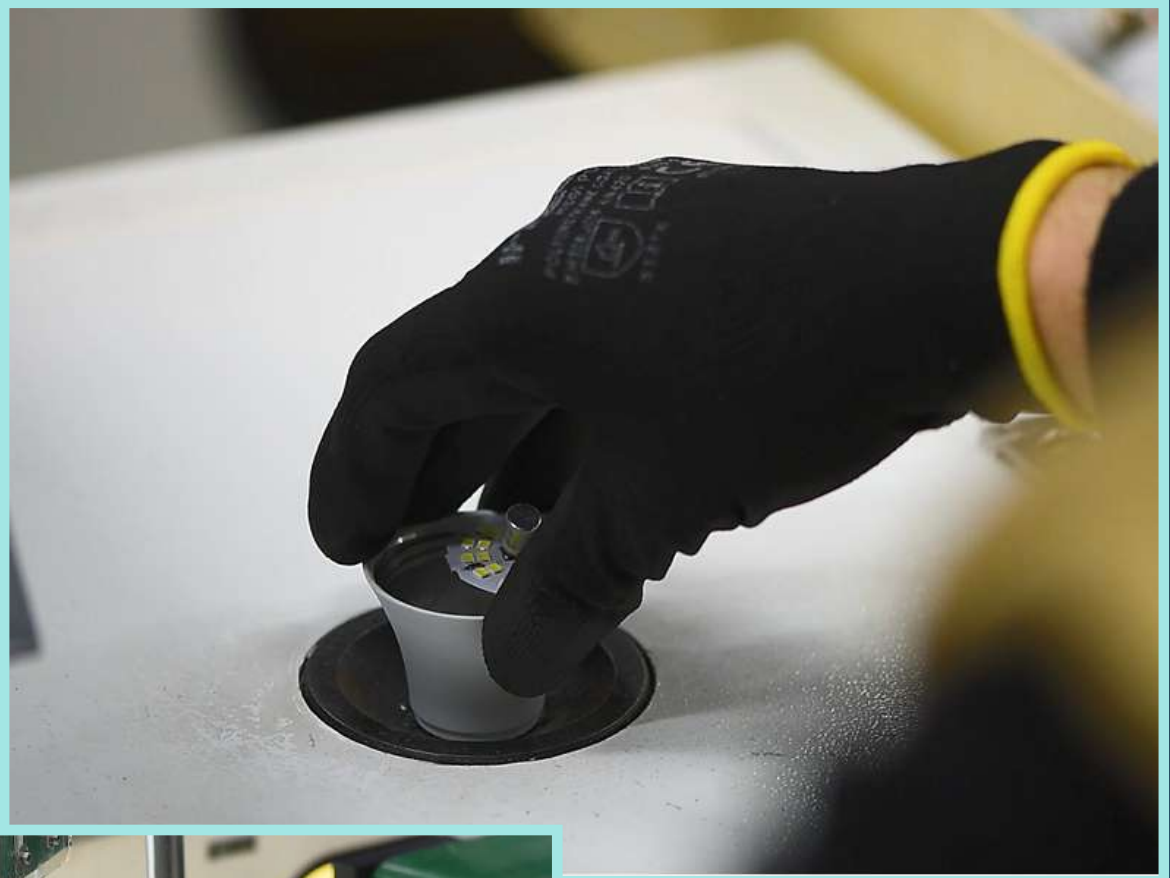





# NO-VO

NO-VO Elektronik & Lighting Factory

+90 555 536 2908

+90 216 394 18 44

no-vo@aferna.com.tr info@no-vo.com.tr www.no-vo.com.tr

novo.elektronik NovoElectronic novoelektronik no-vo-elektronik

İstanbul Organize Sanayi Bölgesi Tuş Sokak No: 8 Tuzla - İstanbul / Türkiye